

Elbow Intermediate R4 Nsf Code- 2F04004

These fittings are made of materials suitable for use in the food industry. They can also be used with hot and cold tap water. The brass parts undergo two successive treatments, unleading, to remove the lead from the surface layer, followed by electrolysis, in which an intermetallic alloy is applied to increase wear and corrosion resistance. Both treatments are patented. The gaskets are made of special FDA-approved Viton®. These fittings do not contain technopolymers, thereby avoiding problems of compatibility with detergents and other chemical agents. This choice of materials allows the fittings to be used up to 150°C, which makes them suitable for other high-temperature applications, in addition to the food industry. The threads are cylindrical and under-head O-rings provide a pneumatic seal. This avoids the need for sealants (e.g. Teflon®), which could release solid fragments during screwing and unscrewing that would contaminate the environment or the fluid. Our fittings can be screwed and unscrewed any number of times and still remain clean and pneumatically sealed. This choice of materials and treatments make these fittings suitable for use in the chemical, pharmaceutical, medical and electronics industry. A standard range of fittings is available, but other designs can be developed on specific request.

GENERAL ATTRIBUTES

- Ref. : R4 NSF
- Diameter (Ø) : 8
- D : 7
- E : 14
- L : 26

COMPONENTS

- Body: unleaded brass treated with environmental ly-friendly intermetallic alloy
- Gripper: unleaded brass treated with environmental ly-friendly intermetallic alloy
- Seal: FDA-approved Viton®
- Port seal: FDA-approved Viton®

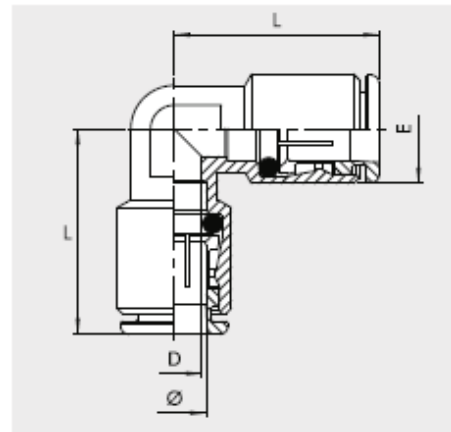

Wiring Diagram

TECHNICAL DATA

- Threaded port : M5 - G1/8" - G1/4" - G3/8" - G1/2"
- Pipe diameter mm : Ø 4 - Ø 6 - Ø 8 - Ø 10
- Temperature range °C : - 20 to + 150
- Pressure range : - 0.99 bar - 16 bar / - 0.099 MPa - 1.6 MPa
- Recommended pipe : Rilsan PA 11 - Nylon 6 - Polyamide 12 - Polypropylene

For further information please visit : <https://goo.gl/TPYAnf>

